

ADVANCE PRINTS

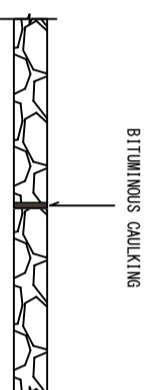

EXPANSION JOINT

DISCHARGE M ³ /S	FREE BOARD-FB	
	EARTHEN CANAL	F. B. (LINING)
0 < 1.0	0.45	0.20
1.0 < 0 < 2.0	0.50	0.20
2.0 < 0 < 5.0	0.75	0.30
5.0 < 0 < 20.0	1.00	0.40
20.0 < 0 < 50.0	1.25	0.60
50.0 < 0	1.50	0.80

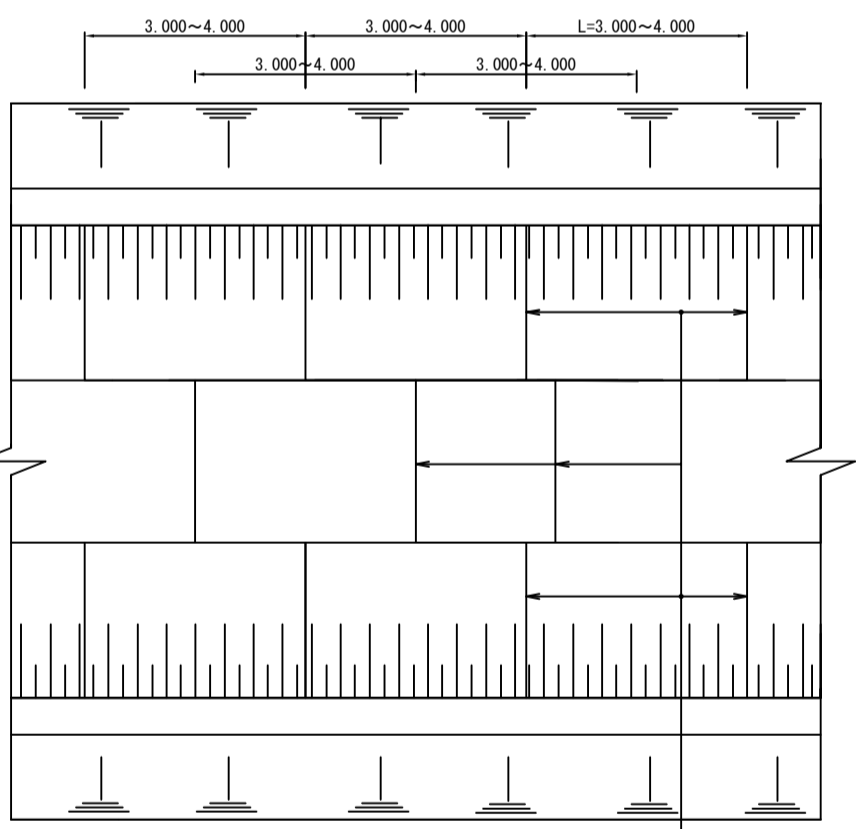
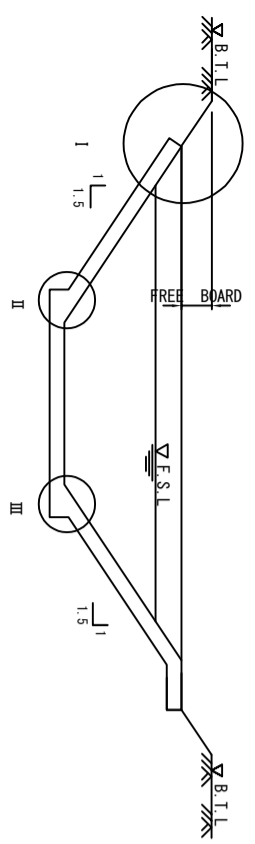
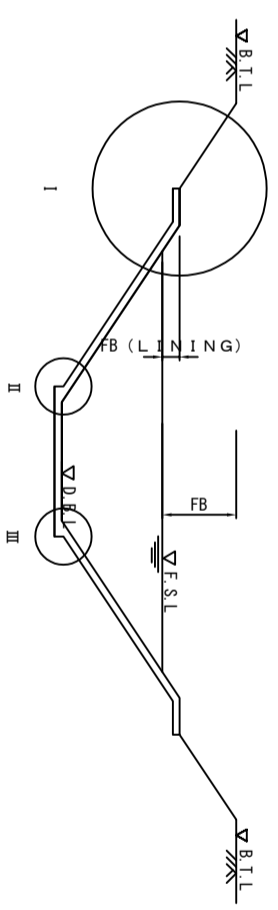

SITUATION OF EXPANSION JOINT
SCALE - 1:125

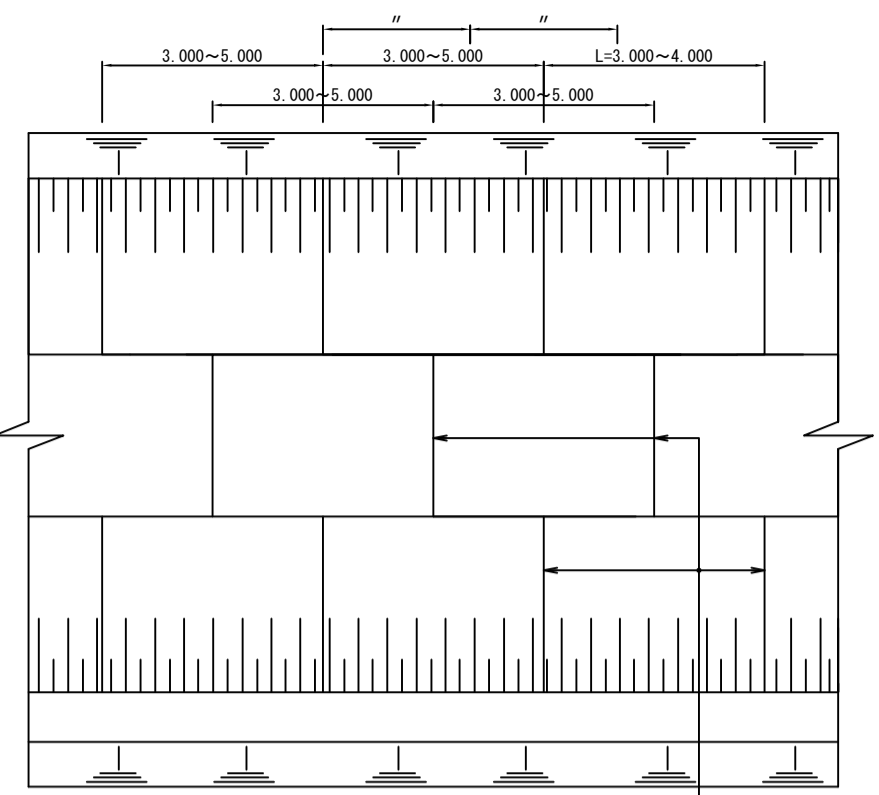

SITUATION OF EXPANSION JOINT
SCALE - 1:125

TYPICAL JOINTS FOR CONCRETE

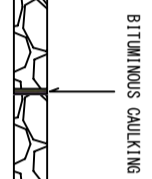

EXPANSION JOINT

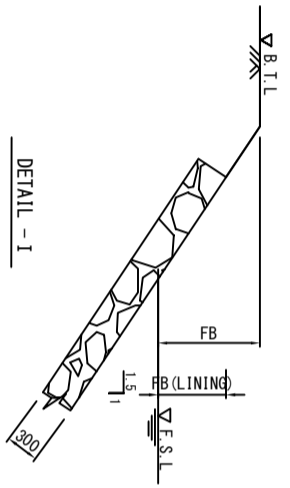

DETAIL - I

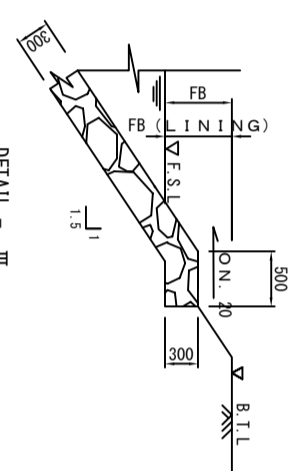

DETAIL - III

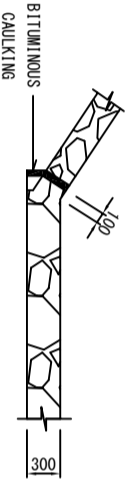

DETAIL - II
SCALE - 1:20

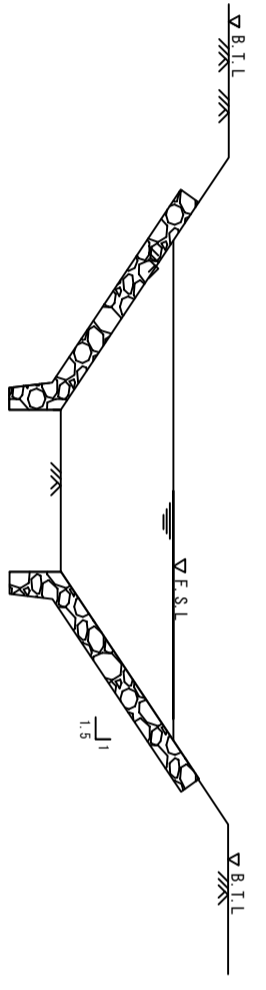

DETAIL - IV
SCALE - 1:20

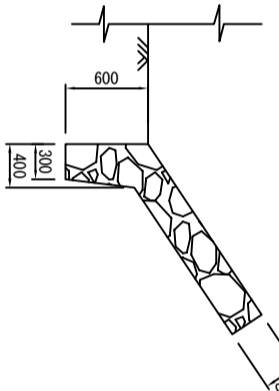

DETAIL - IV - SCALE - 1:50

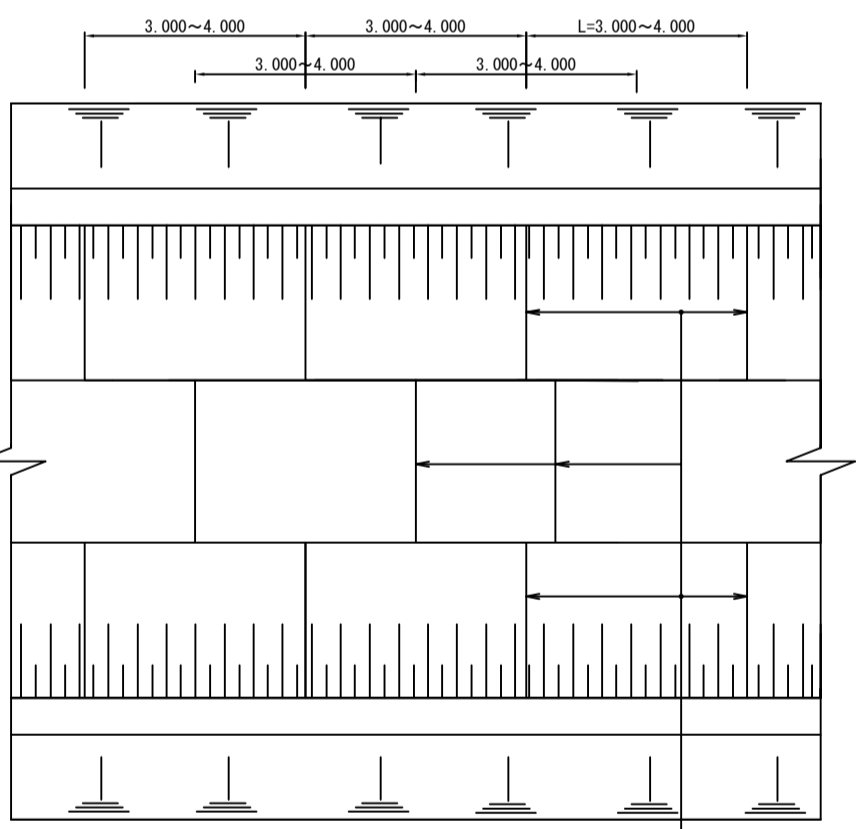
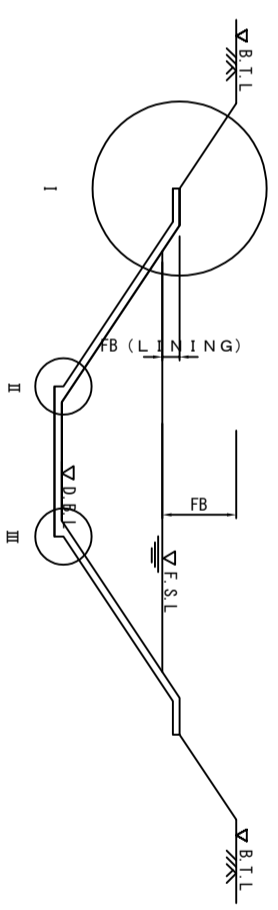

SITUATION OF EXPANSION JOINT
SCALE - 1:125

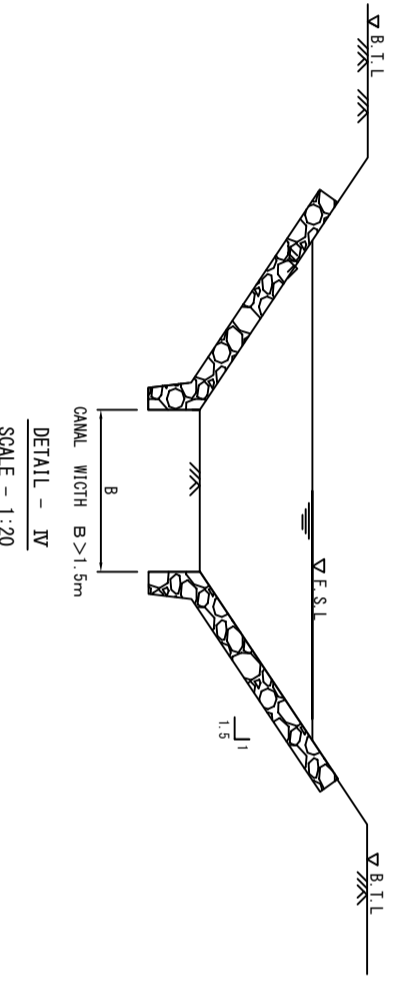

DETAIL - IV
SCALE - 1:20

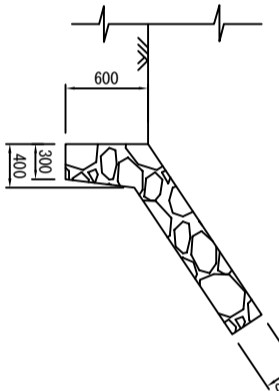

DETAIL - IV - SCALE - 1:50

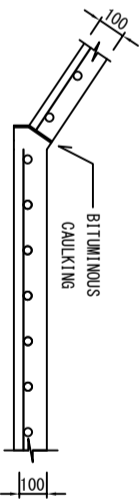

DETAIL - II
SCALE - 1:20

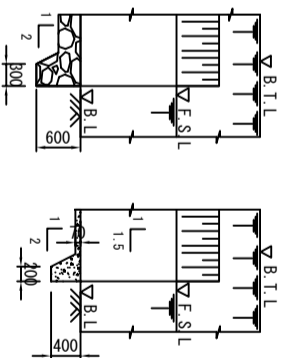

SECTION X-X

DETAIL OF COFFERS
SCALE - 1:50

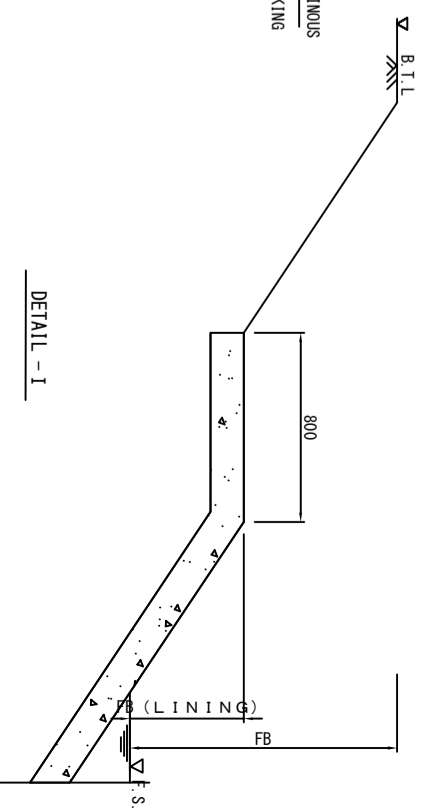

DETAIL - I

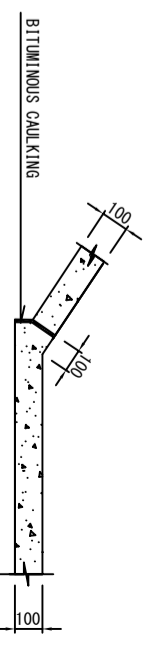

DETAIL - II

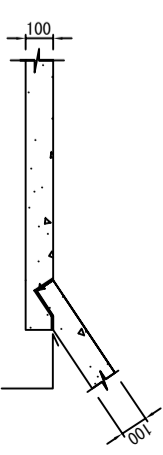

DETAIL - III

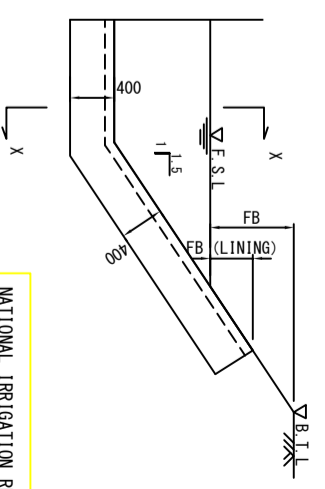

SECTION X-X

CONCRETE CANAL LINING

NATIONAL IRRIGATION REHABILITATION PROJECT
CENTRAL MANAGEMENT CELL

CANAL LINING

APPROVED BY
PROJECT DIRECTOR

DATE: 25-03-96

DRW. N.G.P.T.R
DRW. CHKD.

DE. SD
DES. CHKD
REC. MD

DRG. NO. SHEET NO 2 OF 4